

DATA SHEET - OPERATION MANUAL

APPLICATION

Directional spool valves type WE10... electrically operated are intended for change in direction of fluid flow in a hydraulic system and thus it allows to change direction of movement of a receiver - mostly piston rod of a cylinder or hydraulic motor as well to use functions: *on* and *off*. These directional spool valves are used for subplate mounting in any position in a hydraulic system.

The product is compliant with the regulations of directive 2014/35/UE.

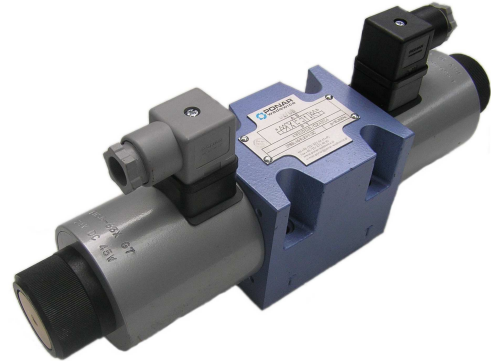

DESCRIPTION OF OPERATION

4WE10G - 62/G24NZ4

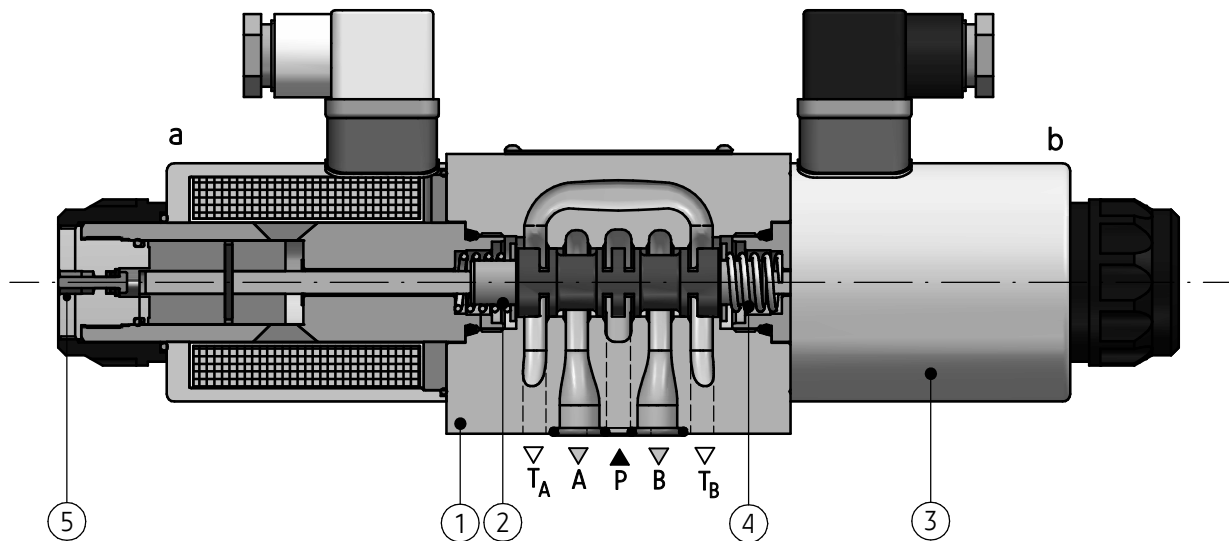

Main elements of directional spool valve type WE10... are: housing (1), solenoids (3), control spool (2), centering springs (4) and manual overrides (5). The spool (2) is shifted when it is moved into one of end positions by the force of solenoid (3) affecting it. The return of the spool into neutral position and centering are secured by the centering springs (4). The shape of the spool (control edge spacing) affects the configuration of connections among the ports: A, B, P and T. Function of ports:

- P - supply port
- T - oil return to the tank
- A, B - ports for a receiver

In case of emergency, the spool can be shifted manually by means of the override (5) - only for version with manual override.

When the situation is anticipated, directional spool valve must be mounted in the way as to be available.

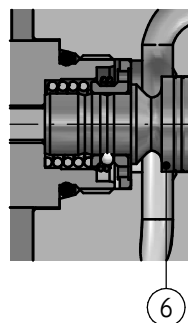

Version WE10.../OF...- only for spools: A, C, D, EA, GA, HA, JA, EB, GB, HB, JB. 2-position directional spool valve without return springs with detent. The spool (2) is positioned and supported with detent (6), and its shift results from supplying voltage to one solenoid (3).

DESCRIPTION OF OPERATION

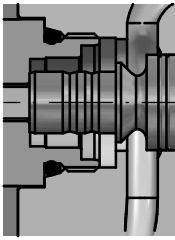

Version WE10.../O...- only for spools: A, C, D, EA, GA, HA, JA, EB, GB, HB, JB.
2-position directional spool valve without return springs. The spool is positioned and supported with attached solenoid. There is no neutral position as the spool is not positioned.

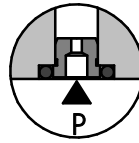

Version WE10.../...B... - directional spool valve designation like that, has throttle insert in port P.

TECHNICAL DATA

Hydraulic fluid	mineral oil						
Required fluid cleanliness class	ISO 4406 class 20/18/15						
Nominal fluid viscosity	37 mm ² /s at temperature 55 °C						
Viscosity range	2,8 up to 380 mm ² /s						
Fluid temperature range (in a tank)	recommended	40°C up to 55°C					
	max	-20°C up to +70°C					
Ambient temperature range	- 20°C up to +50°C						
Maximum operating pressure	ports P, A, B	35 MPa					
	port T	21 MPa					
Flow section in central position diagrams on page 4	spool symbol	Q		W		V	
	flow direction	A → T B → T		A → T B → T		A → T B → T P → A P → B	
	flow section	5,5 mm ²		2,5 mm ²		11 mm ² 10 mm ²	
Weight	with 1 solenoid	WE10...- 4,6 kg				WE10...H...- 7,1 kg	
	with 2 solenoids	WE10...- 6,2 kg				WE10...H...- 8,7 kg	
Supply voltage of solenoids	DC			AC (plug-in connector with rectifier)			AC direct supply
	12V	24V	110V	230V-50Hz	220V- 50Hz	110V- 50Hz	230V- 50Hz
Supply voltage tolerance	±10%						±10%
Power requirement (DC)	45 W						
Holding power (AC)	-						110 VA
Switch-on power (AC)	-						460 VA
Switching time	ON up to 60 ms						ON up to 45 ms
	OFF up to 40 ms						OFF up to 30 ms
Maximum switching frequency	15000 on/h						12000 on/h
Degree of protection	IP 65						
Solenoid coil temperature	max 150 °C						

INSTALLATION AND OPERATION REQUIREMENTS

1. Only fully functional and operational valve, properly connected to electrical installation must be used.
Connecting or disconnecting the valve to an electrical installation must only be carried out by qualified personnel.
2. Ground connection ($\frac{\sphericalangle}{\sphericalangle}$) must be connected with protective earth wire (PE $\frac{\sphericalangle}{\sphericalangle}$) in supply system according to appropriate instructions.
3. Solenoid plug shall precisely adhere to socket and shall be secured with thread bolt screwed in securely in a place. It is forbidden to operate the valve if the tightness and suitable clamp of cable in the plug gland are not ensured.
4. For the ...W230 - 50... versions, simultaneous joining of two solenoids of the same valve should not be permitted (partial overriding of the valve can overheat and damage the winding coils).
5. During the period of operation must be kept fluid viscosity acc. to requirements defined in this Data Sheet - Operation Manual
6. In order to ensure failure free and safe operation the following must be checked:
 - condition of the electrical connection
 - proper working of the valve
 - cleanliness of the hydraulic fluid
7. Due to heating of solenoid coils to high temp., the valve shall be placed in such way to eliminate the risk of accidental contact with solenoid during operation or to apply suitable covers acc. to European standards: PN - EN ISO 13732 - 1 and PN - EN 4413.
8. In order to provide proper tightness of the valve connection to the hydraulic system, one should keep the dimensions of the sealing rings, tightening torques values and valve operation parameters, specified in this Data Sheet - Operation Manual.
9. Valve with spool position sensor is adjusted at factory and it is not allowed to change its settings. In case of any damages of the sensor or valve one must change complete valve. Inductive sensors cannot be joined in series.
10. A person that operates the valve must be thoroughly familiar with this Data Sheet - Operation Manual.

DIAGRAMS

Diagrams for 3-position directional spool valves

Diagrams for 2-position directional spool valves

versions with positions a, 0

versions with positions 0, b

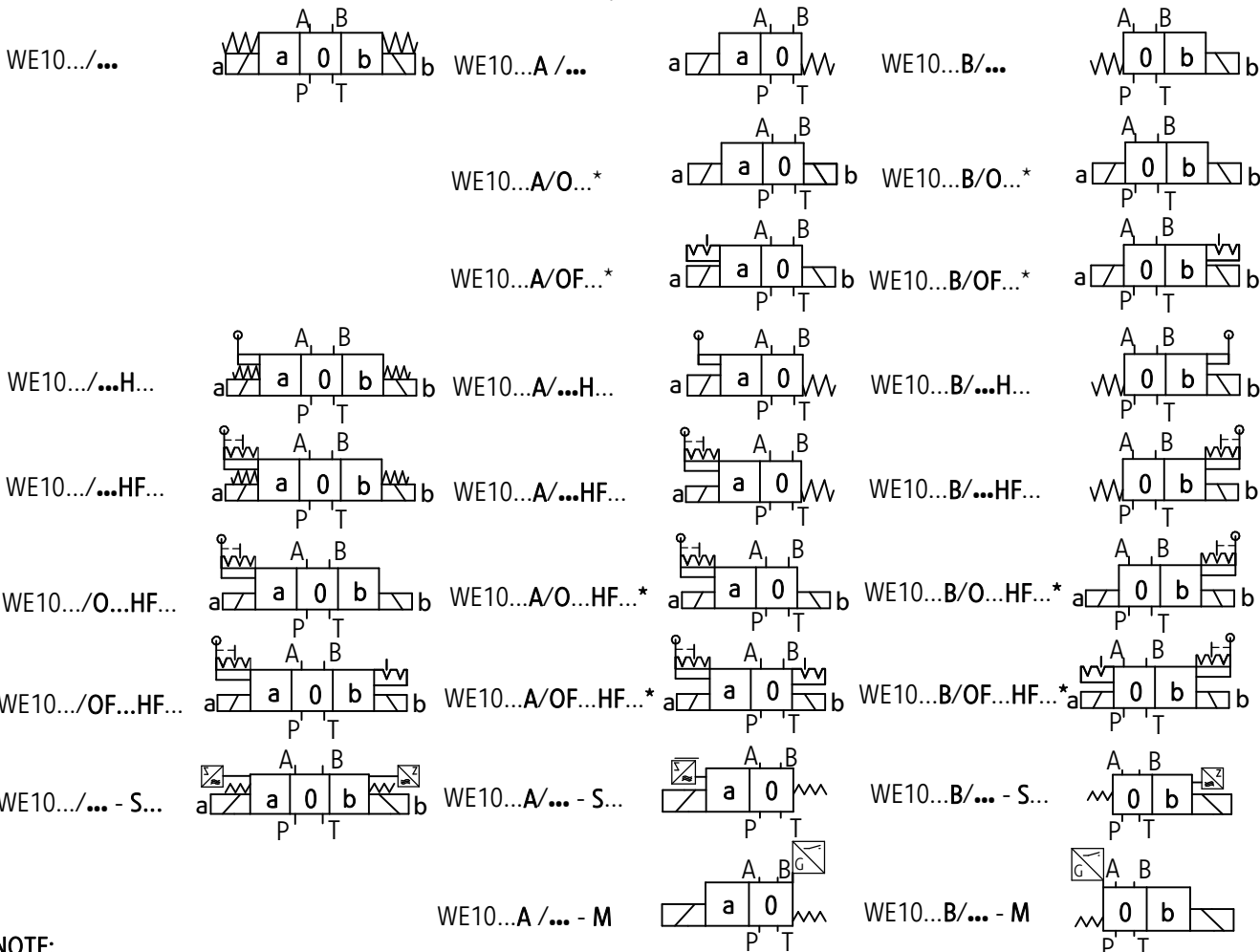

NOTE:

(*) - versions available only with spools - diagrams: E, G, H, J, E, G, H, J - acc. to page 4.

DIAGRAMS

Diagrams for spools

working and indirect positions

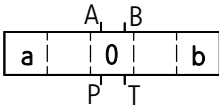

working positions

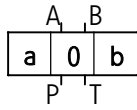

working and indirect positions

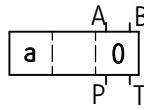

working positions

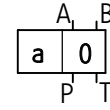

working and indirect positions

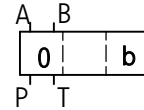

working positions

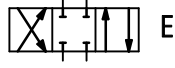
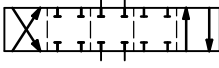
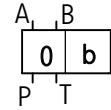

E

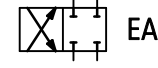

EA

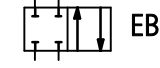
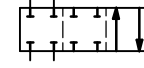

EB

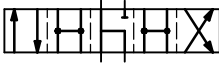

F

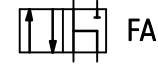
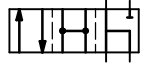

FA

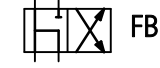
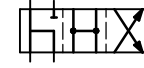

FB

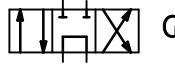
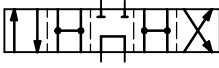

G

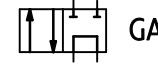

GA

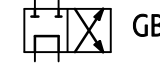
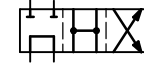

GB

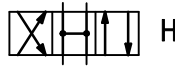

H

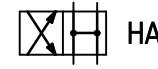

HA

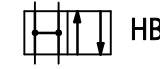

HB

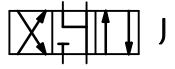

J



JA

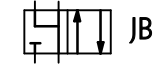
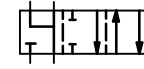

JB

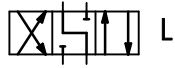

L

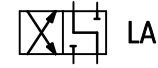

LA

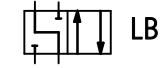
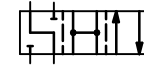

LB

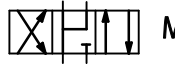
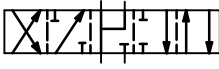

M



MA

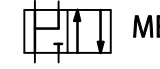
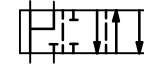

MB

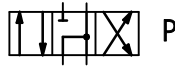
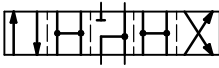

P

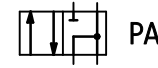

PA

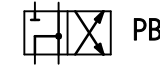
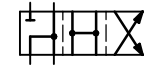

PB

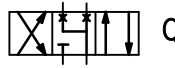

Q*



QA*

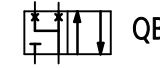
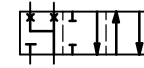

QB*

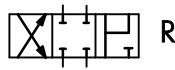
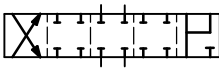

R

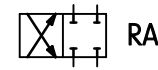
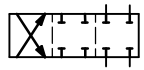

RA

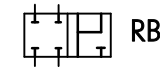
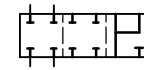

RB

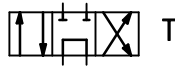
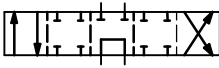

T

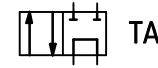
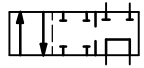

TA

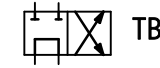
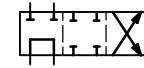

TB

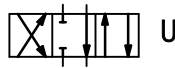
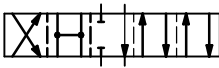

U

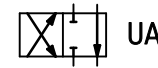

UA

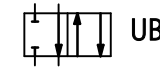
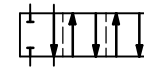

UB

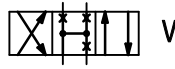

V*



VA*

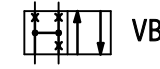
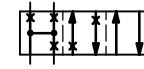

VB*

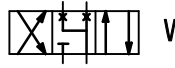

W*



WA*

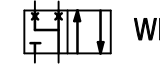
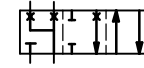

WB*

NOTE:

(*) - flow section in initial position for spools: Q, V, W - according to page 2.

DIAGRAMS

Diagrams for 2-position directional spool valves
versions with positions a, b

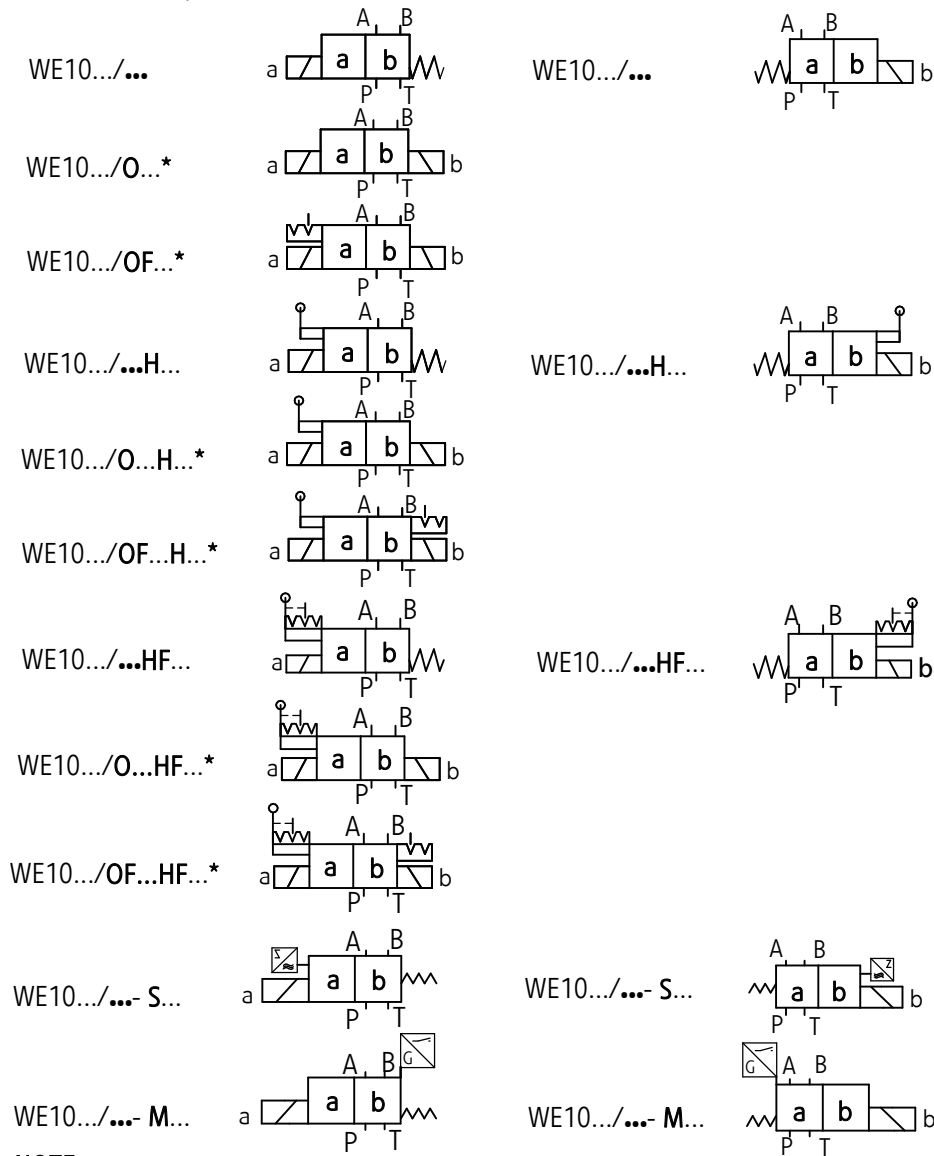

NOTE:

(*) - versions available only with spools - diagrams: A, C, D

Diagrams for spools

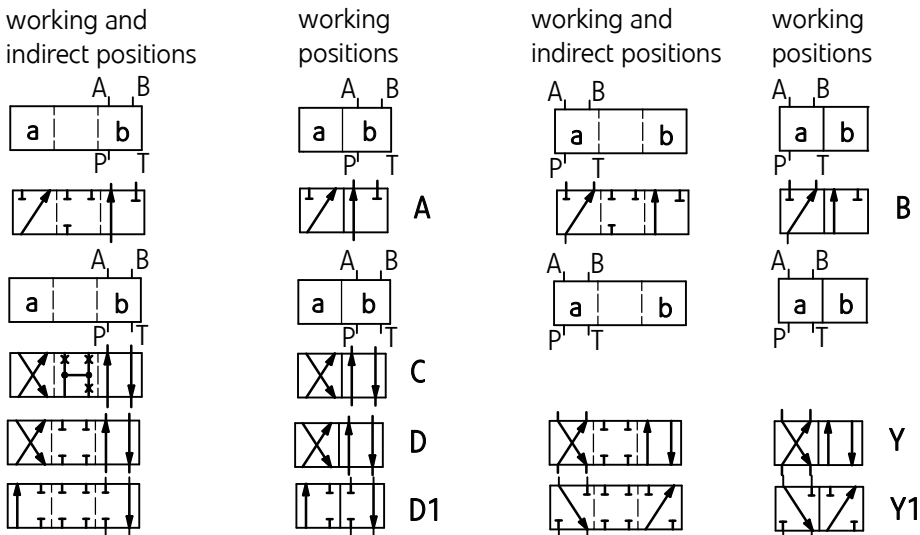

OVERALL AND CONNECTION DIMENSIONS

version WE10.../...Z4... (electrical connection type ISO 4400)

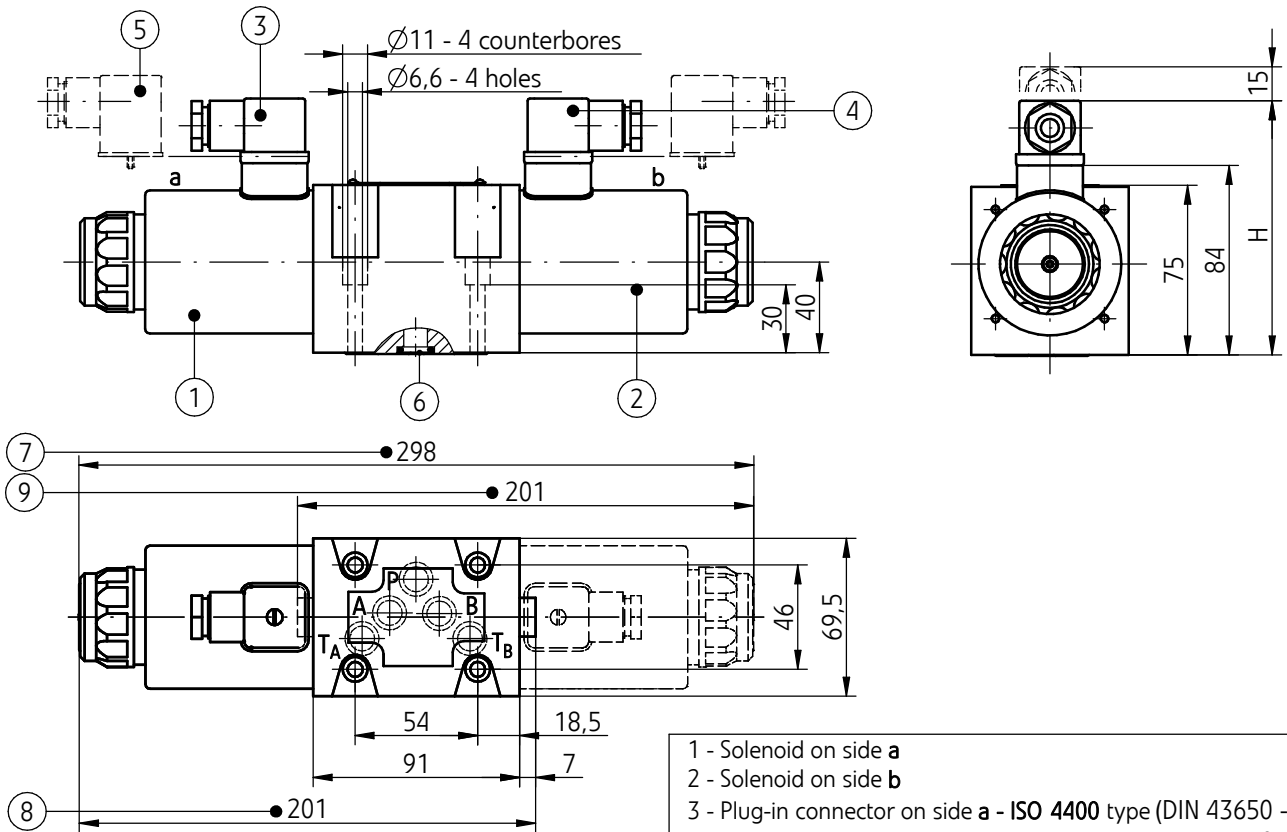

Option of electrical connection ...Z4... (ISO 4400)		H
plug-in connector ISO 4400 (DIN 43650 - A)	control voltage (DC) 12V, 24V, 110V	112
plug-in connector ISO 4400 (DIN 43650 - A) with rectifier	control voltage (AC) 110V, 220V, 230V	119

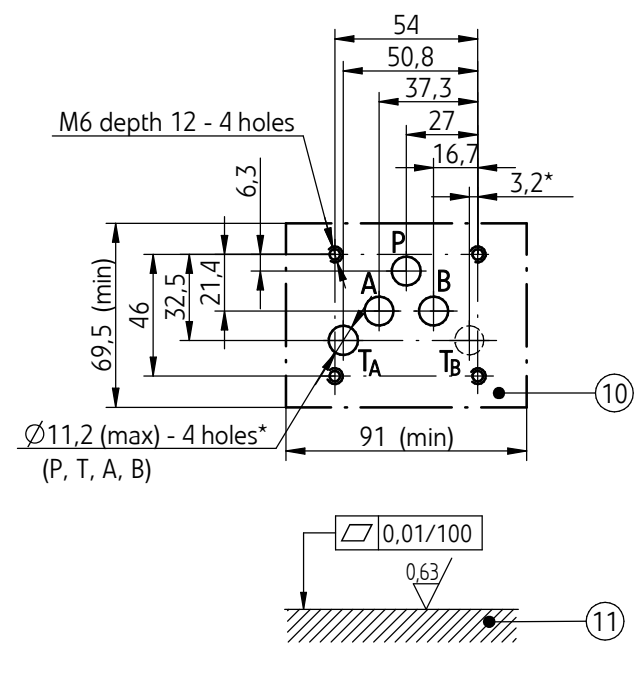

- 1 - Solenoid on side a
- 2 - Solenoid on side b
- 3 - Plug-in connector on side a - ISO 4400 type (DIN 43650 - A)
- 4 - Plug-in connector on side b - ISO 4400 type (DIN 43650 - A)
- 5 - Plug-in connector - ISO 4400 type (DIN 43650 - A) with rectifier
- 6 - O-ring 12,42 x 1,78 - 5 pcs/set (P, TA, TB, A, B)
- 7 - Directional spool valve dimension with 2 solenoids on side a, b:
 - 3-position directional spool valve springs center d (spool diagrams: E, F, G, H, J, L, M, P, Q, R, T, U, V, W - according to page 4)
 - 2-position directional spool valve without return springs
 - 2-position directional spool valve without springs and with detent (versions WE10 .../O...; .../OF...; spool diagrams: A, C, D, EA, GA, HA, JA, EB, GB, HB, JB - according to pages 4, 5)
- 8 - Directional spool valve dimension with 1 solenoid - on side a
 - 2-position springs centered (spool diagrams: A, C, D, D1, EA, FA, GA, HA, JA, LA, MA, PA, QA, RA, TA, UA, VA, WA - according to pages 4, 5)
- 9 - Directional spool valve dimension with 1 solenoid - on side b
 - 2-position springs centered (spool diagrams: B, Y, Y1, EB, FB, GB, HB, JB, LB, MB, PB, QB, RB, TB, UB, VB, WB - according to pages 4, 5)
- 10 - Porting pattern for directional spool valve - configuration of connection holes in accordance with the standard ISO 4401* - designation ISO 4401-05-04-0-94 (CETOP 05) (*) - connection with 1 hole T from the side of the hole A or B is enough - holes TA and TB are connected with the port in the housing of directional spool valve; fixing screws M6 x 40 - 10.9 - in accordance with PN-EN ISO 4762 - 4 pcs/set; must be ordered separately; tightening torque Md = 15 Nm.
- 11 - Subplate surface required

OVERALL AND CONNECTION DIMENSIONS

version WE10.../...W230-50...Z4... (AC solenoids; electrical connection type ISO 4400)

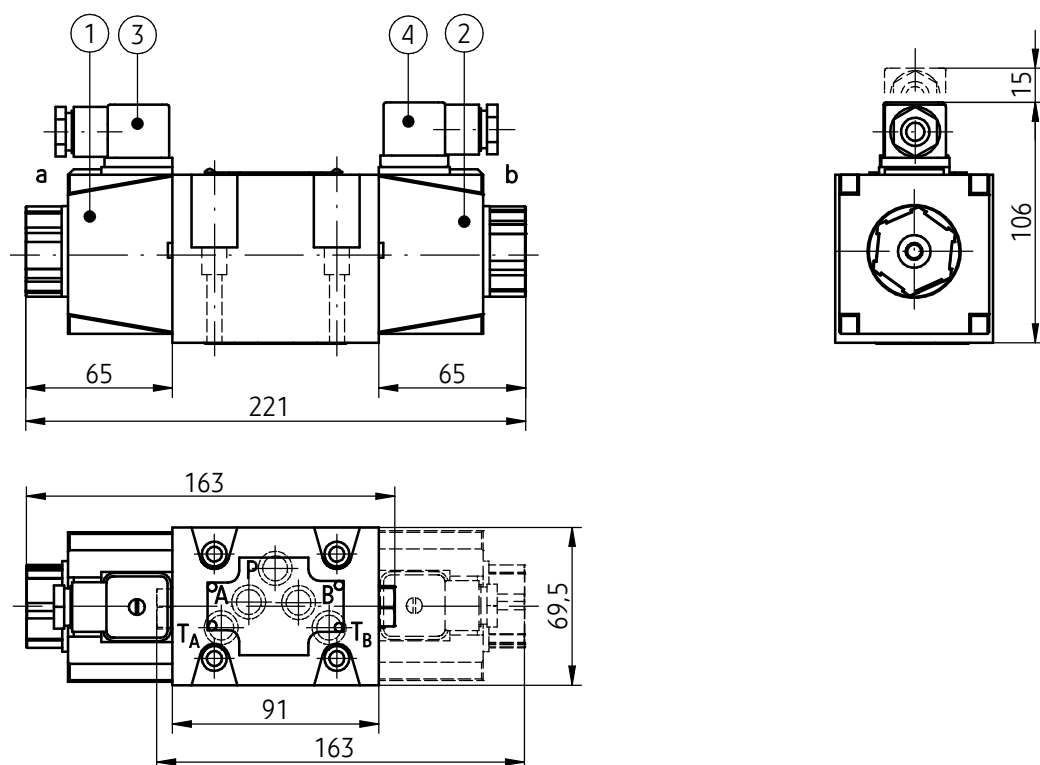

NOTES:

- other dimensions, description of other elements of the valve drawing; porting pattern and requirements of the surface state of the subplate - as in version WE10.../...Z4... with DC solenoids, see page 6
- details for version WE10.../...W230-50...H Z4... (with manual control lever) as in versions WE10.../...H...Z4... with DC solenoids, see page 8 - 11

- 1 - AC solenoid (with direct supply) from the **a** side
- 2 - AC solenoid (with direct supply) from the **b** side
- 3 - Plug-in connector on side **a** - type ISO 4400 (DIN 43650 - A)
- 4 - Plug-in connector on side **b** - type ISO 4400 (DIN 43650 - A)

NOTE:

simultaneous joining of two solenoids of the same valve should not be permitted (partial overriding of the valve can overheat and damage the winding coils)

OVERALL AND CONNECTION DIMENSIONS

3-position versions WE10.../...H Z4...; .../...HS Z4...

2-position versions WE10.../O...H Z4...; .../OF... H Z4...

WE 10.../O...HS Z4...; .../OF...HS Z4...

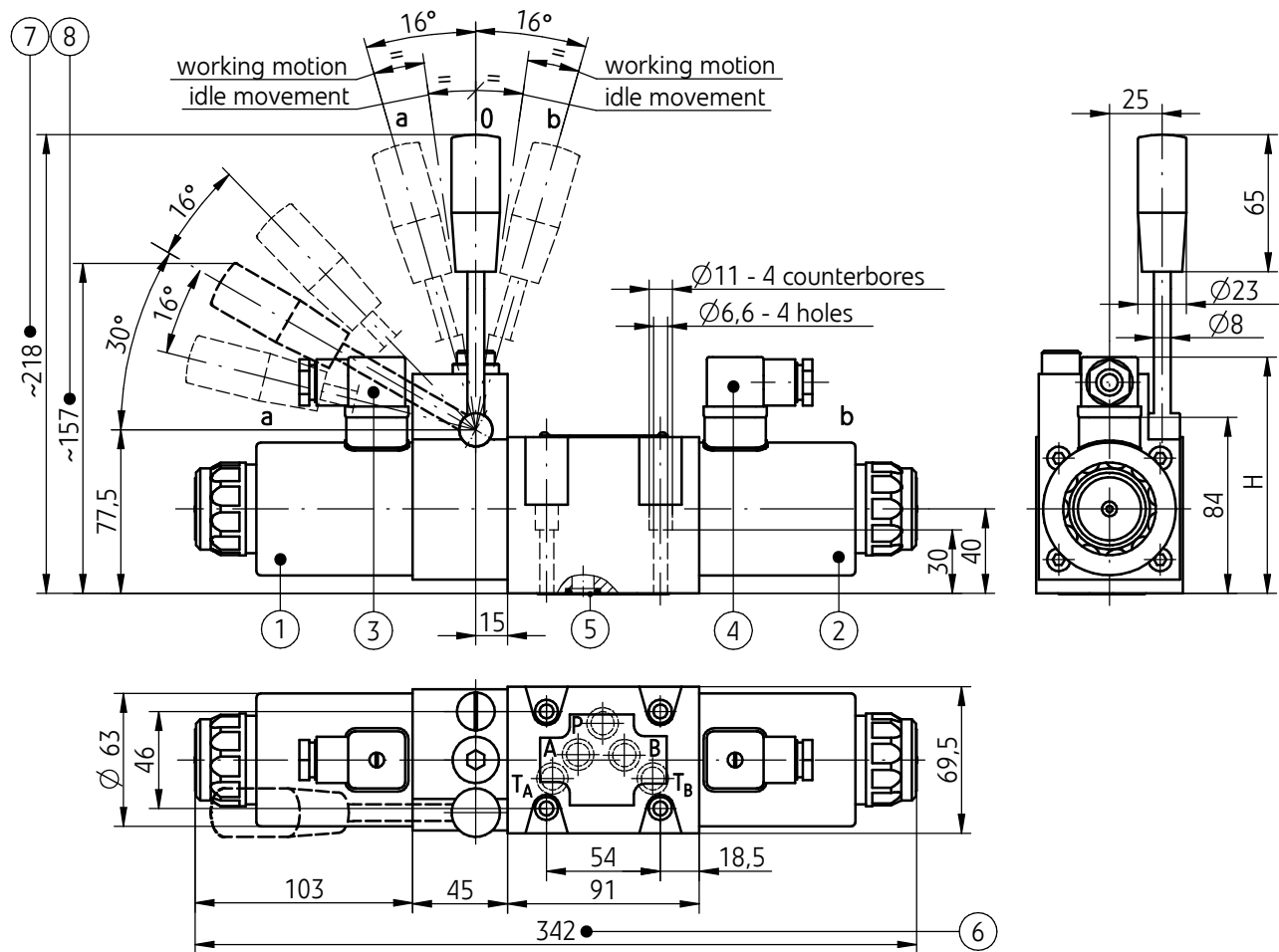

Option of electrical connection ...Z4... (ISO 4400)		H
plug-in connector ISO 4400 (DIN 43650 - A)	control voltage (DC) 12V, 24V, 110V	112
plug-in connector ISO 4400 (DIN 43650 - A) with rectifier	control voltage (AC) 110V, 220V, 230V	119

NOTES:

Porting pattern and requirements of the surface state of the subplate - as in version WE10.../...Z4... see page 6

NOTES:

- the valve is switched by the manual control lever, return of the lever to the initial (neutral) state occurs automatically
- after switching the valve by using the solenoid, the lever remains inactive.

- Solenoid on side **a**
- Solenoid on side **b**
- Plug-in connector on side **a** - type ISO 4400 (DIN 43650 - A)
- Plug-in connector on side **b** - type ISO 4400 (DIN 43650 - A)
- O-ring 12,42 x 1,78 - 5 pcs/set (P, T_A, T_B, A, B)
- Directional spool valve dimension with 2 solenoids on side **a**, **b**:

- 3-position directional spool valve springs centered versions WE10.../...H...; ...HS... (spool diagrams: E, F, G, H, J, L, M, P, Q, R, T, U, V, W - acc. to page 4)

- 2-position directional spool valve without returns springs - versions WE10.../O...H...; .../O...HS... (spool diagrams: A, C, D, EA, GA, HA, JA, EB, GB, HB, JB acc. to pages 5, 6)

- 2-position directional spool valve without springs and with detent - versions WE10.../OF...H...; .../OF...HS... (spool diagrams: A, C, D, EA, GA, HA, JA, EB, GB, HB, JB acc. to pages 5, 6)

7 - Manual control lever positions in versions:
WE10.../...H...; WE10.../O...H...; .../OF...H...

8 - Manual control lever positions in versions:
WE10.../...HS...; WE10.../O...HS...; .../OF...HS...

OVERALL AND CONNECTION DIMENSIONS

2-position versions WE10.../...H Z4...; ...HS Z4...

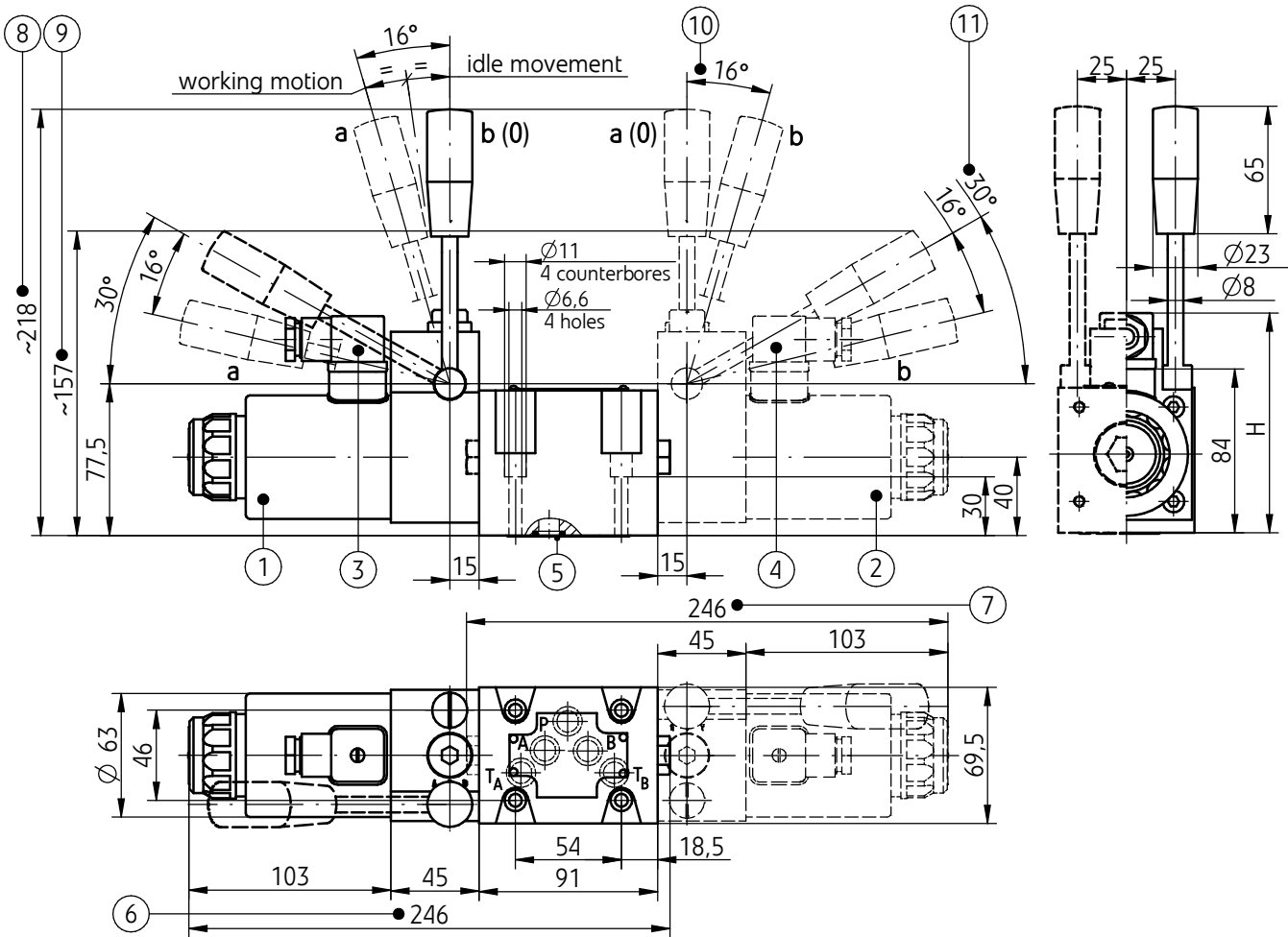

Option of electrical connection ...Z4... (ISO 4400)		H
plug-in connector ISO 4400 (DIN 43650 - A)	control voltage (DC) 12V, 24V, 110V	112
plug-in connector ISO 4400 (DIN 43650 - A) with rectifier	control voltage (AC) 110V, 220V, 230V	119

NOTES:
Porting pattern and requirements of the surface state of the subplate - as in version WE10.../...Z4... see page 6

NOTES:

- the valve is switched by the manual control lever, return of the lever to the initial (neutral) state occurs automatically
- after switching the valve by using the solenoid, the lever remains inactive.

- Solenoid on side a
- Solenoid on side b
- Plug-in connector on side a - type ISO 4400 (DIN 43650 - A)
- Plug-in connector on side b - type ISO 4400 (DIN 43650 - A)
- O-ring 12,42 x 1,78 - 5 pcs/set (P, T_A, T_B, A, B)
- Directional spool valve dimension with 1 solenoid - on side a, 2-position with return spring - versions WE10.../...H...; ...HS... (spool diagrams: A, C, D, D1, EA, FA, GA, HA, JA, LA, MA, PA, QA, RA, TA, UA, VA, WA - acc. to pages 4, 5)
- Directional spool valve dimension with 1 solenoid - on side b, 2-position with return spring - versions WE10.../...H...; ...HS... (spool diagrams: B, Y, Y1, EB, FB, GB, HB, JB, LB, MB, PB, QB, RB, TB, UB, VB, WB - acc. to pages 4, 5)
- Manual control lever positions in versions: WE10.../...H... with 1 solenoid - on side a
- Manual control lever positions in versions: WE10.../...HS... with 1 solenoid - on side a
- Manual control lever positions in versions: WE10.../...H... with 1 solenoid - on side b
- Manual control lever positions in versions: WE10.../...HS... with 1 solenoid - on side b

OVERALL AND CONNECTION DIMENSIONS

3-position versions WE10.../...HF Z4...

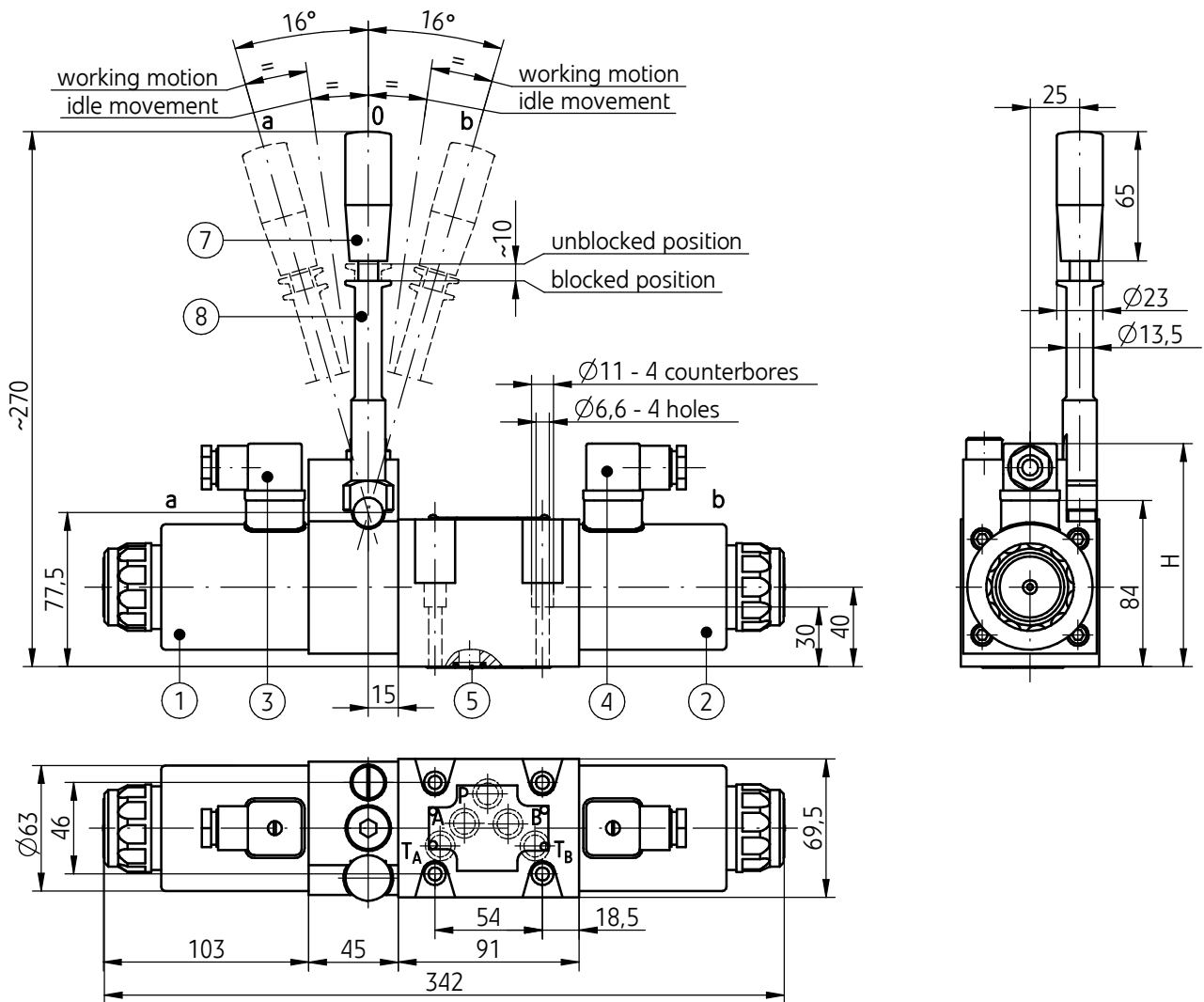

Option of electrical connection ...Z4... (ISO 4400)		H
plug-in connector ISO 4400 (DIN 43650 - A)	control voltage (DC) 12V, 24V, 110V	112
plug-in connector ISO 4400 (DIN 43650 - A) with rectifier	control voltage (AC) 110V, 220V, 230V	119

NOTES:

- Porting pattern and requirements of the surface state of the subplate - as in version WE10.../...Z4... see page 6.
- The valve is switched by the manual control lever (7), return of the lever to the initial (neutral) state occurs automatically. In order for the lever (7) to remain in switched position, one should move the block sleeve (8) downwards to a halt. After switching the valve by the electromagnet, the lever (7) is not active.

- 1 - Solenoid on side a
- 2 - Solenoid on side b
- 3 - Plug-in connector on side a - type ISO 4400 (DIN 43650 - A)
- 4 - Plug-in connector on side b - type ISO 4400 (DIN 43650 - A)
- 5 - O-ring 12,42 x 1,78 - 5 pcs/set (P, T_A, T_B, A, B)
- 6 - Directional spool valve dimension with 2 solenoids on side a, b:
 - 3-position directional spool valve springs centered version WE10.../...HF... (spool diagrams: E, F, G, H, J, L, M, P, Q, R, T, U, V, W - acc. to page 4)
 - 2-position directional spool valve without return springs - version WE10.../O...HF... (spool diagrams: A, C, D, EA, GA, HA, JA, EB, GB, HB, JB acc. to pages 5, 6)
 - 2-position directional spool valve without springs and with detent - version WE10.../OF...HF... (spool diagrams: A, C, D, EA, GA, HA, JA, EB, GB, HB, JB acc. to pages 5, 6)
- 7 - Manual control lever
- 8 - Manual control lever block sleeve

OVERALL AND CONNECTION DIMENSIONS

2-position versions WE10.../...HF Z4...

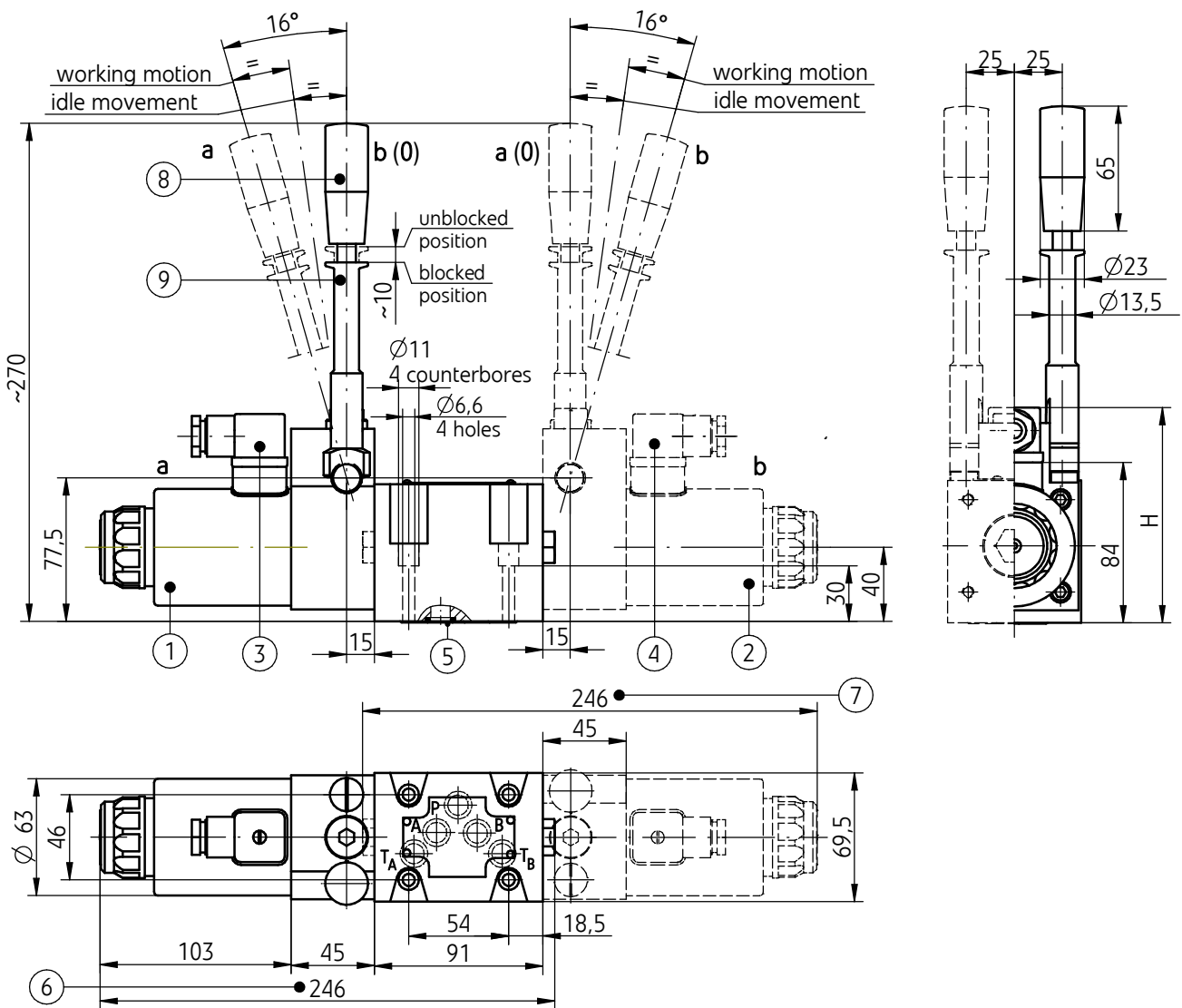

Option of electrical connection ...Z4... (ISO 4400)		H
plug-in connector ISO 4400 (DIN 43650 - A)	control voltage (DC) 12V, 24V, 110V	112
plug-in connector ISO 4400 (DIN 43650 - A) with rectifier	control voltage (AC) 110V, 220V, 230V	119

NOTES:

- Porting pattern and requirements of the surface state of the subplate - as in version WE10.../...Z4... see page 6.
- The valve is switched by the manual control lever (7), return of the lever to the initial (neutral) state occurs automatically. In order for the lever (7) to remain in switched position, one should move the block sleeve (8) downwards to a halt. After switching the valve by the electromagnet, the lever (7) is not active.

- 1 - Solenoid on side a
- 2 - Solenoid on side b
- 3 - Plug-in connector on side a - type ISO 4400 (DIN 43650 - A)
- 4 - Plug-in connector on side b - type ISO 4400 (DIN 43650 - A)
- 5 - O-ring 12,42 x 1,78 - 5 pcs/set (P, T_A, T_B, A, B)
- 6 - Directional spool valve dimension with 1 solenoid on side a; 2-position spring positioned version WE10...A/...HF... (spool diagrams: A, C, D, D1, EA, FA, GA, HA, JA, LA, MA, PA, QA, RA, TA, UA, VA, WA acc. to pages 4, 5)
- 7 - Directional spool valve dimension with 1 solenoid on side b; 2-position spring positioned version WE10...B/...HF... (spool diagrams: B, Y, Y1, EB, FB, GB, HB, JB, LB, MB, PB, QB, RB, TB, UB, VB, WB acc. to pages 4, 5)
- 7 - Manual control lever
- 8 - Manual control lever block sleeve

PERFORMANCE CURVES

measured at viscosity $\nu = 41 \text{ mm}^2/\text{s}$ and temperature $t = 50^\circ\text{C}$

Flow resistance curves

characteristic curves $\Delta p(Q)$ for directional spool valve type WE10... for various spool types

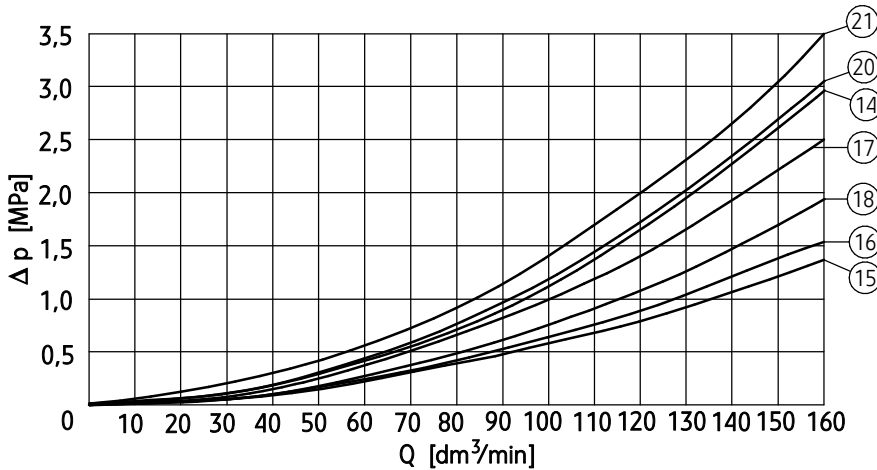
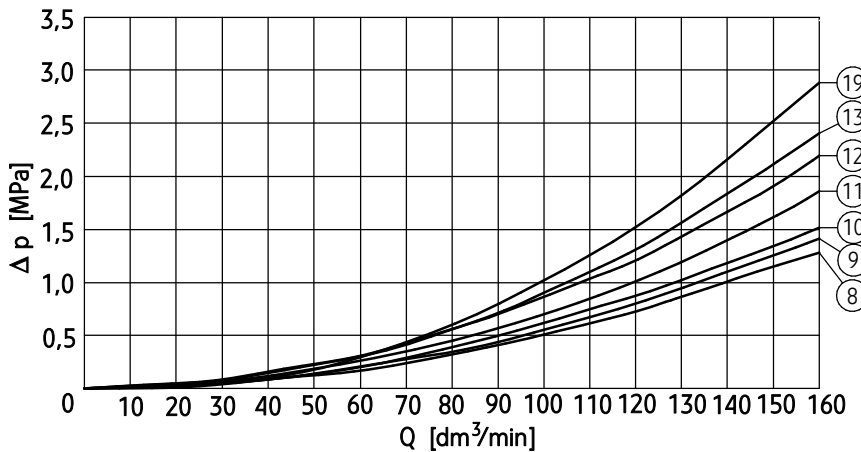
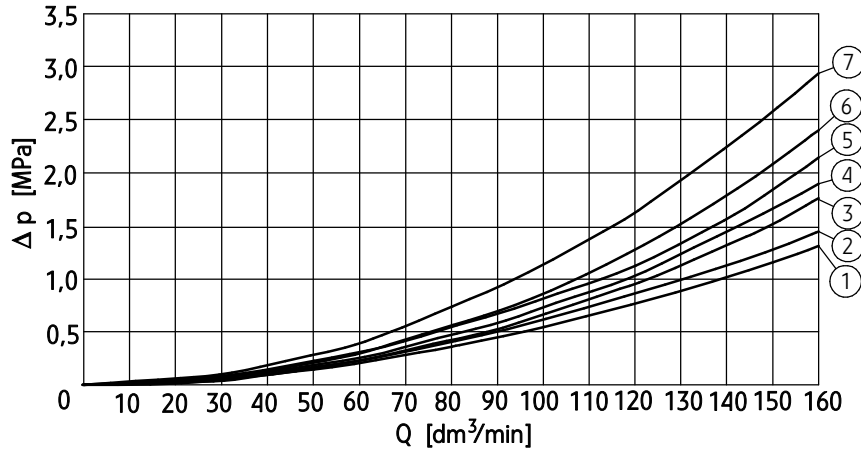

spool symbol diagrams acc. to pages 4, 5	characteristic curve number flow direction			
	P → A	P → B	A → T	B → T
A	6	6	-	-
B	12	12	-	-
C	12	12	8	8
D	5	5	16	16
Y	9	9	7	7
E	3	3	8	8
F	11	12	6	7
G	14	14	12	12
H	3	3	2	2
J	3	3	12	12
L	13	13	12	12
M	4	4	1	1
P	12	11	7	6
Q	13	13	1	6
R	14	16	8	-
T	2	2	10	10
U, V	13	13	10	10
W	13	13	1	15
D1	2	-	-	2
Y1	-	2	2	-

spool symbol initial position (0) diagrams acc. to page 4	characteristic curve number flow direction					
	P → A	P → B	P → T	A → T	B → T	B → A
F	7	-	20	20	-	-
P	-	7	21	-	19	-
G, T	-	-	17	-	-	-
H	-	-	18	-	-	-

spool symbol shifted position b diagram acc. to page 4	characteristic curve number flow direction					
	P → A	P → B	P → T	A → T	B → T	B → A
R	-	-	-	-	-	20

PERFORMANCE CURVES

measured at viscosity $\nu = 41 \text{ mm}^2/\text{s}$ and temperature $t = 50^\circ\text{C}$

Operating limits curves

characteristic curves p - Q for directional spool valve type WE10... with DC solenoids for various spool types

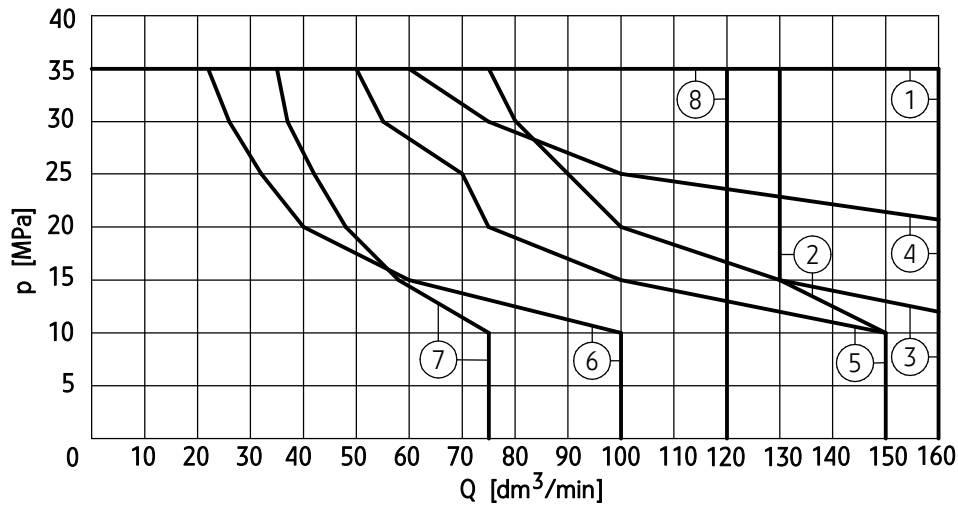

spool symbol diagrams acc. to pages 4, 5	characteristic curve number
E, H, EA/O, EB/O,	1
M, EA/OF, EB/OF	2
G	3
Q, W	4
F, P	5
A	6
B	7
V, JA/O, JB/O, JA/OF, JB/OF	8

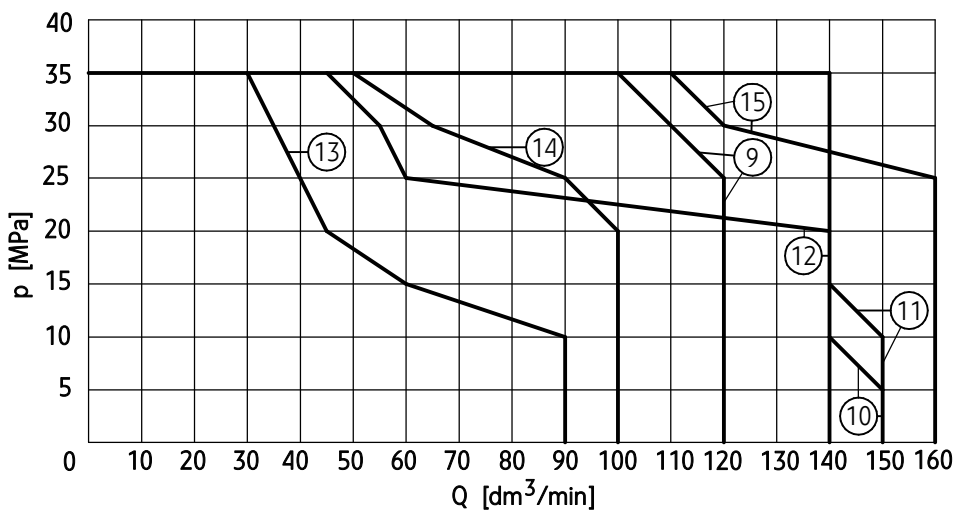

spool symbol diagrams acc. to pages 4, 5	characteristic curve number
C	9
D	10
Y	11
U	12
T	13
L	14
HA/O, HB/O, HA/OF, HB/OF	15

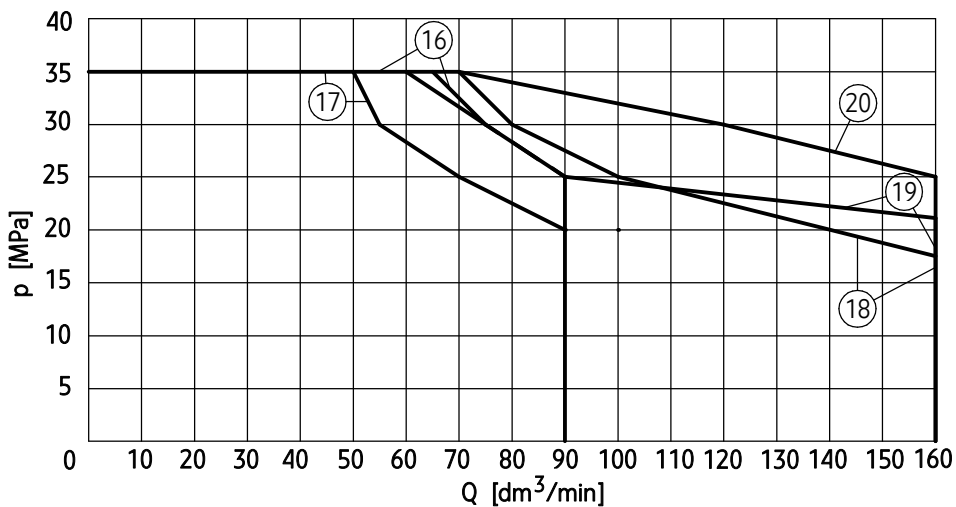

spool symbol diagrams acc. to pages 4, 5	characteristic curve number
D1	16
Y1	17
R	18
J	19
GA/O, GB/O, GA/OF, GB/OF	20

NOTES:

Above operating limits are related to symmetrical flow through all ports i.e. if the oil flows from port P to port A, then the same flow rate is from port B to port T

(applied to directional control valves with 4 service ports). Degree of asymmetry affects adversely the parameters.

PERFORMANCE CURVES

measured at viscosity $\nu = 41 \text{ mm}^2/\text{s}$ and temperature $t = 50^\circ\text{C}$

Operating limits curves

characteristic curves p-Q for directional spool valve type WE10... with AC solenoids with direct supply for various spool types

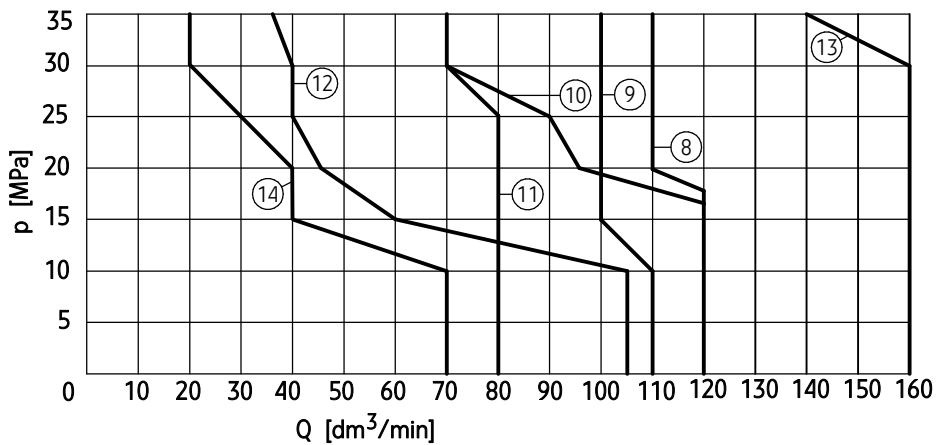
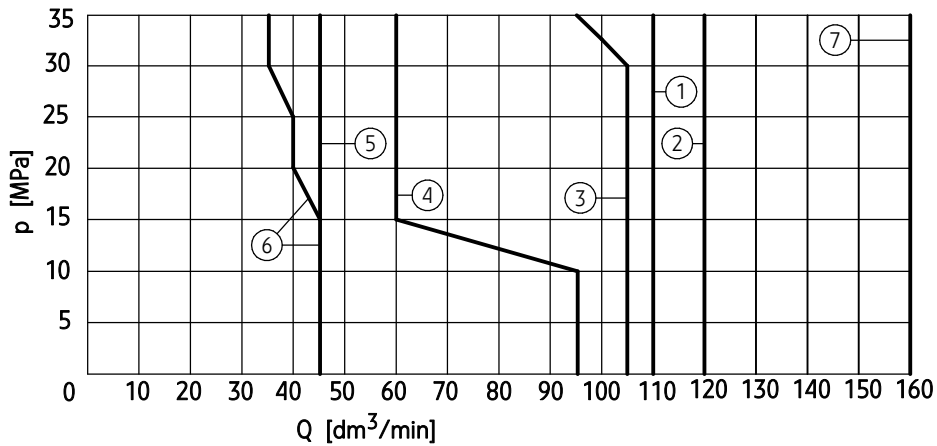

spool symbol diagrams acc. to pages 4, 5	characteristic curve number
E, W	1
D	2
L	3
H	4
V	5
P	6
JA/O, JB/O, JA/OF, JB/OF, EA/O, EB/O, EA/OF, EB/OF, HA/O, HA/OF	7
C, Y	8
M, Q	9
J	10
U	11
G	12
HA/OF, HB/OF	13
GA/O, GB/O, GA/OF, GB/OF	14

NOTES:

Above operating limits are related to symmetrical flow through all ports i.e. if the oil flows from port P to port A, then the same flow rate is from port B to port

T (applied to directional control valves with 4 service ports). Degree of asymmetry affects adversely the parameters.

ACCESSORIES

Spool position switch type S

Additional technical specification

Inductive switch type S	
Version	PNP inductive proximity switch
Range of supply voltage for switch	10 - 30V DC
Max load current	200 mA
Connection type of switch	switch with M12 x1 external thread; male connection; 4 contacts (pins)
Degree of protection	IP 65
Weight	
with 1 solenoid and 1 switch	5,6 kg
with 2 solenoids and 1 switch	7,2 kg
with 2 solenoids and 2 switches	8,5 kg

Diagram of electrical connection of inductive switch type S

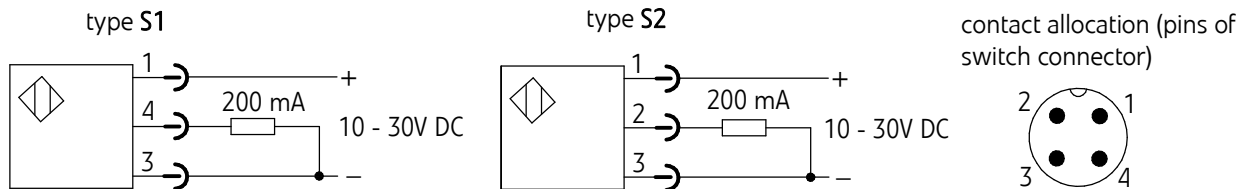

Diagrams for directional control valves and initial positions of switches

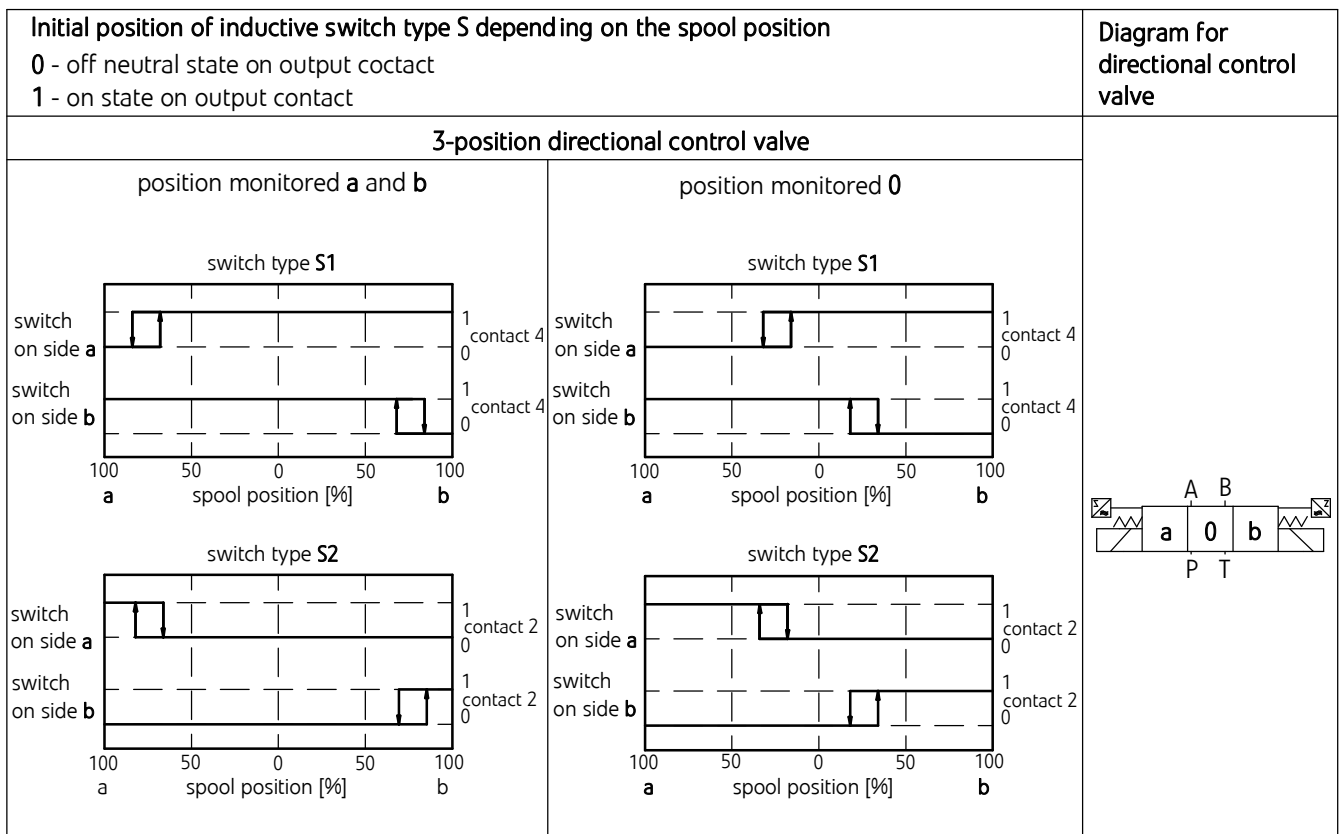

ACCESSORIES

Spool position switch type S

Initial position of inductive switch depending on the spool position		Diagram for directional control valve
2-position versions WE10...A... (positions: a, 0) solenoid and switch on side a		
<p style="text-align: center;">position monitored a</p>	<p style="text-align: center;">position monitored 0</p>	
2-position versions WE10...B... (positions: 0, b) solenoid and switch on side b		
<p style="text-align: center;">position monitored 0</p>	<p style="text-align: center;">position monitored b</p>	
2-position versions WE10A...; ...C...; ...D...; .../O...; .../OF... (switch on side a)		
<p style="text-align: center;">position monitored a</p>	<p style="text-align: center;">position monitored b</p>	
2-position versions WE10B...; ...Y... (switch on side b)		
<p style="text-align: center;">position monitored a</p>	<p style="text-align: center;">position monitored b</p>	

ACCESSORIES

Spool position switch type S

Overall dimensions

version with 2 solenoids and 2 switches

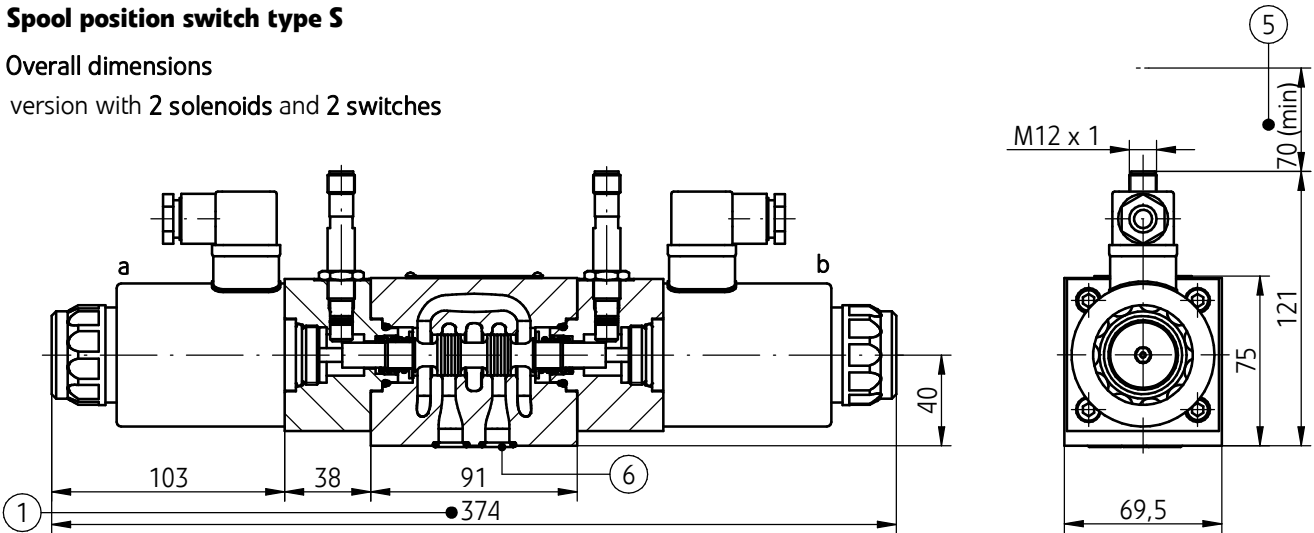

version with 1 solenoid and 1 switch

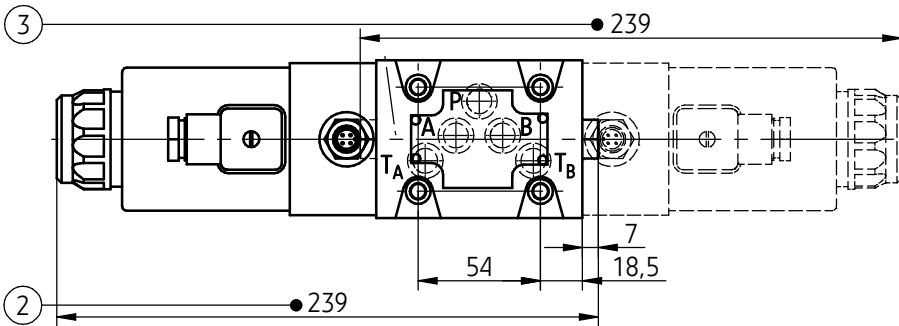

version with 2 solenoids and 1 switch

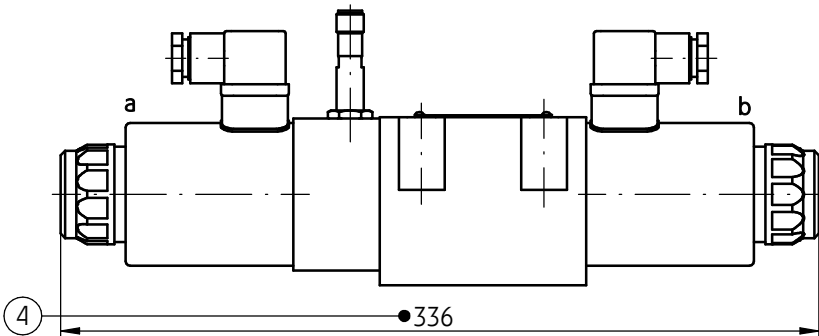

NOTES:

Directional control valve with spool position switch is adjusted. Any adjustments may be made only by the manufacturer.

In case of a faulty switch or valve complete directional control valve must be changed.

NOTE: subplate surface required according to page 6

- 1 - Dimension of directional control valve with 2 solenoids - on side a, b and 2 position switches
 - 3-position, springs centered
 - versions WE10.../...S1...; ...S2... (spool diagrams: E, F, G, H, J, L, M, P, Q, R, T, U, V, W - acc. to page 4)
- 2 - Dimension of directional control valve with 1 solenoid - on side a and 1 position switch
 - 2-position, with return spring
 - versions WE10.../...S1...; ...S2... (spool diagrams: A, C, D, EA, FA, GA, HA, JA, LA, MA, PA, QA, RA, TA, UA, VA, WA - according to pages 4, 5)
- 3 - Dimension of directional control valve with 1 solenoid - on side b and 1 position switch
 - 2-position, with return spring
 - versions WE10.../...S1... ...S2... (spool diagrams:

- B, Y, EB, FB, GB, HB, JB, LB, MB, PB, QB, RB, TB, UB, VB, WB - according to pages 4, 5)
- 4 - Dimension of directional control valve with 2 solenoids - on side a, b and 1 position switch on side a
 - 2-position, without spring return
 - versions WE10.../O...S1...; ...S2...
 - 2-position, without spring return, with detent
 - versions WE10.../OF...S1...; ...S2... (spool diagrams: A, C, D - according to page 5)
- 5 - Distance for mounting plug-in-connector and cable of switch (plug-in-connectors not showed in the drawing must be ordered separately according to data sheet WK 499 963)
- 6 - O-ring 12,42 x 1,78 - 5 pcs/set (P, T_A, T_B, A, B)

ACCESSORIES

Spool position switch type M

(only for 2-position versions with return spring)

Additional technical data

Inductive switch type M	
	switch with 2 alternative output type PNP
Range of supply voltage for switch	24 VDC $\begin{matrix} +20\% \\ -10\% \end{matrix}$
Max load current	400 mA
Connection type of switch	switch with M12 x 1 external thread; 4 contacts (pins)
Degree of protection	IP 65
Weight (directional valve with switch)	4,6 kg
WARNING: M type inductive sensors must not be connected serially	

Diagram of electrical connection of inductive switch type M

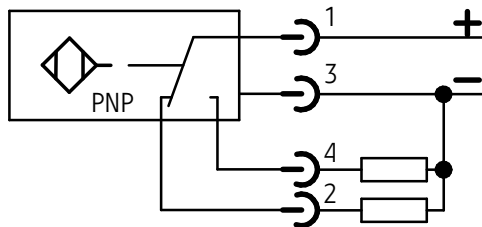

contact allocation (pins of switch connector)

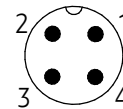

Diagrams for directional control valves and initial positions of switches

Initial position of inductive switch type M depending on the spool position		Diagram for directional control valve
0 - off neutral state on output contact 1 - on state on output contact		
2-position versions WE10...A... (positions: a, 0) solenoid on side a and switch on side b		
<p>position monitored a</p>	<p>position monitored 0</p>	
2-position versions WE10...B... (positions: 0, b) solenoid on side b and switch on side a		
<p>position monitored 0</p>	<p>position monitored b</p>	

ACCESSORIES

Spool position switch type M

(only for 2-position versions with return spring)

Graphic symbols for directional control valves and initial positions of switches

Initial position of inductive switch type M depending on the spool position		Diagram for directional control valve
0 - off neutral state on output contact 1 - on state on output contact		
2-position versions WE10A...; ...C...; ...D...; ...D1... switch on side b		
position monitored a 	position monitored b 	
2-position versions WE10B...; ...Y...; ...Y1... switch on side a		
position monitored a 	position monitored b 	

ACCESSORIES

Spool position switch type M

(only for 2-position versions with return spring)

Overall dimensions

version with solenoid on side a and switch type M

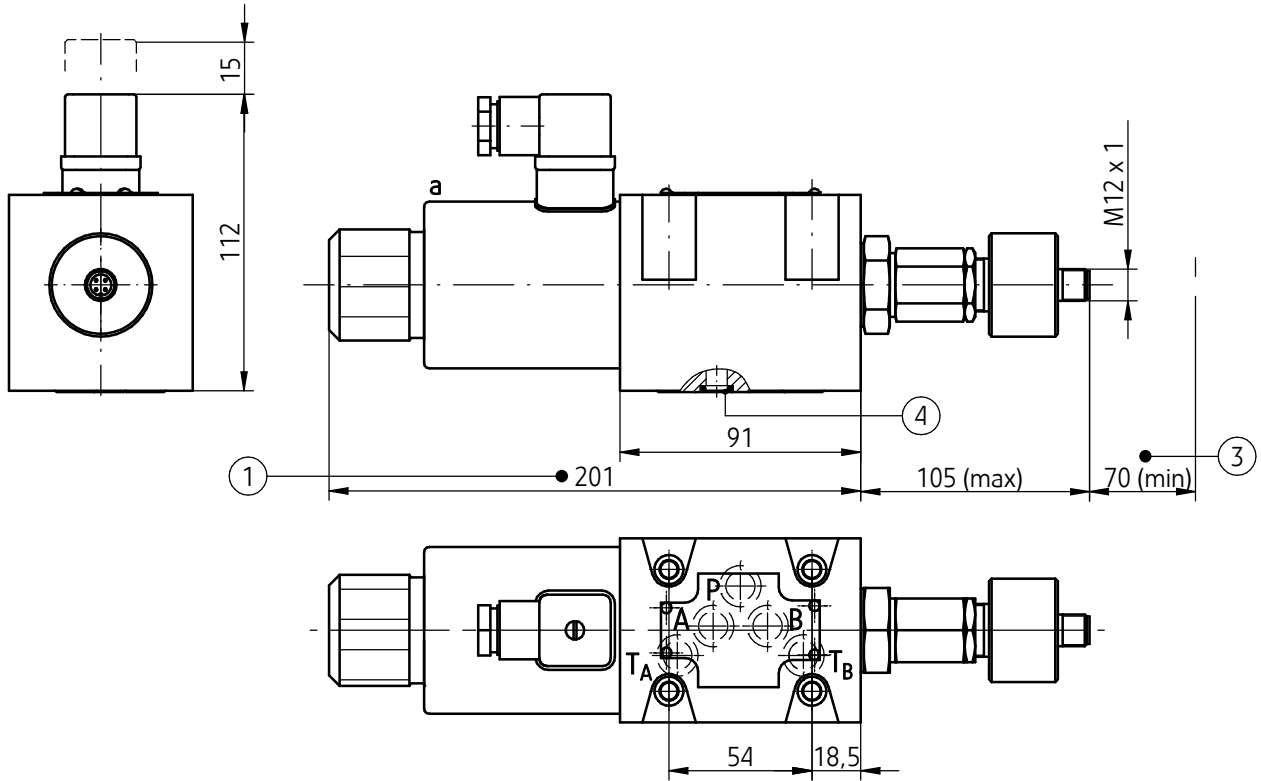

version with solenoid on side b and switch type M

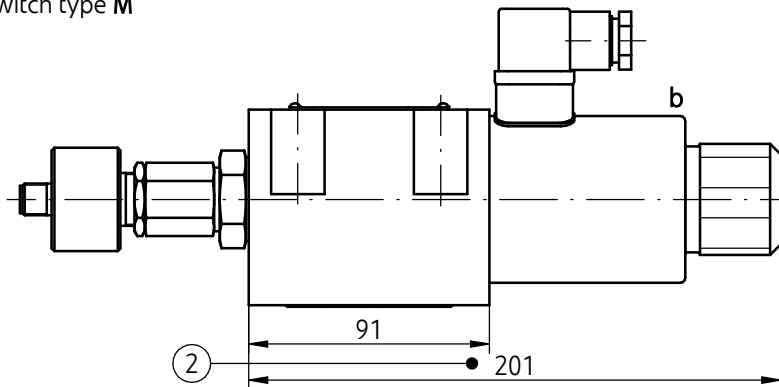

NOTE: subplate surface required according to page 6

NOTES:

Directional control valve with spool position switch is adjusted. Any adjustments may be made only by the manufacturer.

In case of a faulty switch or valve complete directional control valve must be changed.

- 1 - Dimension of directional control valve with 1 solenoid - on side a and switch type M
 - 2-position, with return spring (spool diagrams: A, C, D, D1, EA, FA, GA, HA, JA, LA, MA, PA, QA, RA, TA, UA, VA, WA - according to pages 4, 5)
- 2 - Dimension of directional control valve with 1 solenoid - on side b and switch type M
 - 2-position, with return spring (spool diagrams: B, Y, Y1, EB, FB, GB, HB, JB, LB, MB, PB, QB, RB, TB, UB, VB, WB - according to pages 4, 5)
- 3 - Distance for mounting plug-in connector and cable of switch (plug-in connectors not showed in the drawing must be ordered separately according to data sheet WK 499 963)
- 4 - O-ring 12,42 x 1,78 - 5 pcs/set (P, T_A, T_B, A, B)

SUBPLATES AND FIXING SCREWS

Subplates must be ordered according to data sheet

WK 496 520. Subplate symbols:

G 66/01 - threaded connections G 3/8

G 67/01 - threaded connections **G 1/2**

G 89/01 - threaded connections G 1/4

G 67/02 - threaded connections M22 x 1,5

G 534/01 - threaded connections G 3/4

Subplates and fixing screws **M6 x 40 - 10,9** - acc. to **PN - EN ISO 4762** - 4 pcs/set must be ordered separately.

Tightening torque **Md = 15 Nm**.

NOTE:

Subplate symbol in bold is the preferred version available in short delivery time.

EXAMPLE OF APPLICATION IN HYDRAULIC SYSTEM

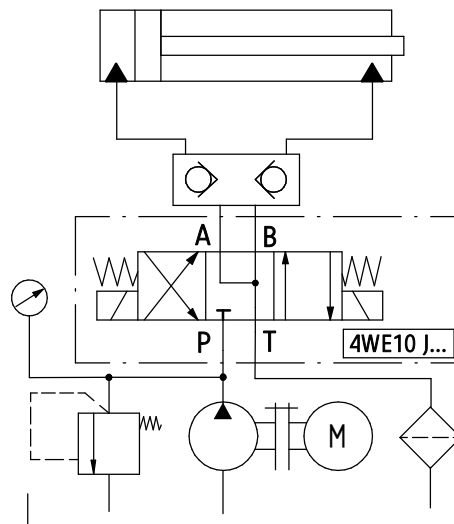

HOW TO ORDER

	WE	10	+	/																
--	-----------	-----------	---	---	--	--	--	--	--	--	--	--	--	--	--	--	--	--	--	--

Number of service ports
3-way - only for spools A, B = **3**
4-way - for the other spools = **4**

Nominal size (NS)
NS10 = **10**

Spool symbol
spool diagrams - according to pages **4, 5**

Series number
 (60-69) - connection and installation dimensions unchanged = **6X**
series 62 = **62**

Spool positioning
spring centering = **no designation**
 without springs return
 (only for spools A, C, D, EA, GA, HA, JA, EB, GB, HB, JB) = 0
 without springs return with detent
 (only for spools A, C, D, EA, GA, HA, JA, EB, GB, HB, JB) = OF

Control voltage for solenoids
 12V DC = G12
24V DC = **G24**
 110V DC = G110
 110V AC 50Hz (plug-in-connector with rectifier) = W110R
 220V AC 50Hz (plug-in-connector with rectifier) = W220R
230V AC 50Hz (plug-in-connector with rectifier) = **W230R**
 230V AC 50 Hz (direct supply with AC current) = W230-50

Manual override
solenoids with manual override = **N**
 solenoids without manual override (only for version with inductive switch type M) = no designation

Manual lever control
no manual control lever = **no designation**
 with a manual control lever positioned vertically = H
 with a manual control lever positioned vertically z blokadą = HF
 with a manual control lever positioned at an angle = HS

Electrical connection
plug-in-connector type ISO 4400 (DIN 43650 - A) **without LED** = **Z4**
 plug-in-connector type ISO 4400 (DIN 43650 - A) with LED = Z4L

Throttle insert (in port P)
without throttle insert = **no designation**
 throttle insert ϕ 0,8 = B 08
 throttle insert ϕ 1,0 = B 10
 throttle insert ϕ 1,2 = B 12
 throttle insert ϕ 3,0 = B 30

HOW TO ORDER

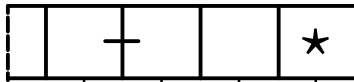

Further requirements in clear text
(to be agreed with the manufacturer)

Monitored position of the spool

monitored position 0 - zero (<i>3- position and 2- position versions with positions (a, 0) or (0, b)</i>)	= 0
monitored position a (<i>2- position versions with positions (a, 0) or (a, b)</i>)	= A
monitored position b (<i>2- position versions with positions (0, b) or (a, b)</i>)	= B
monitored position a and b (<i>3- position versions</i>)	= AB

Spool position switch

spool position switch type S1	= S1
spool position switch type S2	= S2
spool position switch type M (only for 2-positions versions with return spring)	= M

NOTES:

Optional version with a spool position switch and a manual control lever (options: ...H...; ...HS...; ...HF...) available after consultation with the manufacturer.

Sealing

NBR (for fluids on mineral oil base)	= no designation
FKM (for fluids on phosphate ester base)	= V

NOTES:

Directional spool valve should be ordered according to the above coding.

The symbols in bold are preferred versions in short delivery time.

Coding example: 4WE10 E - 62/G24 N Z4 B08 - S1AB

PONAR Wadowice S.A.
ul. Wojska Polskiego 29
34-100 Wadowice
tel. +48 33 488 21 00
fax. +48 33 488 21 03
www.ponar-wadowice.pl

